

CWI LIGHTING

BRIGHTER LIVING. SIMPLIFIED.

PROJECT: _____

FIXTURE TYPE: _____

LOCATION: _____

CONTACT/PHONE: _____

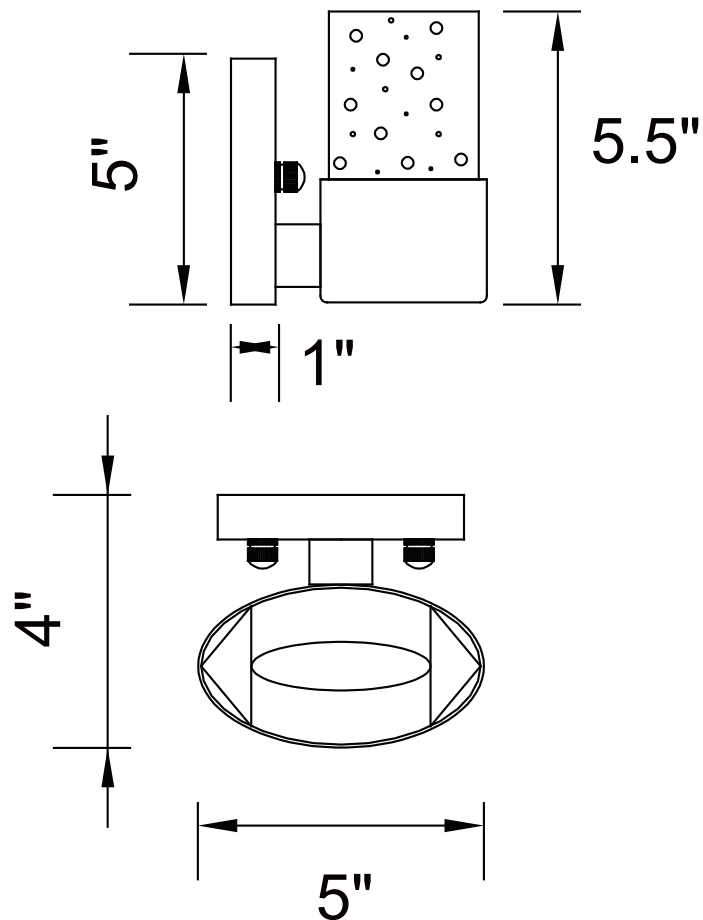

Item	1061W5-1-601
Collection	EMMANUELLA
Finish	Chrome
Glass	-----
Crystal	Clear
Input	120V AC,60HZ,AC

Shade	-----
Length/Dia.	5"
Width/Ext.	4"
Height	5.5"
Maximum	5.5"
Lumens	-----

Light Source	LED+G9
Bulb Info.	1x40W
Included	-----
Dimmable	No
Color	-----
Weight	1.8KG