

# CWI LIGHTING

BRIGHTER LIVING. SIMPLIFIED.

PROJECT: \_\_\_\_\_

FIXTURE TYPE: \_\_\_\_\_

LOCATION: \_\_\_\_\_

CONTACT/PHONE: \_\_\_\_\_

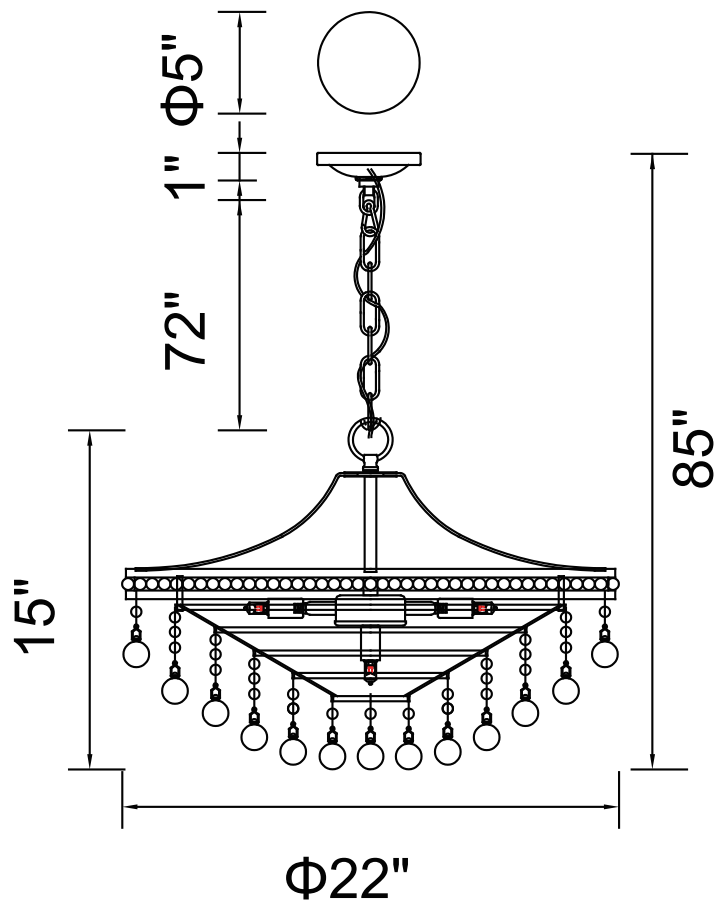

Item	1070P22-9-601
Collection	SERAPHINA
Finish	Chrome
Glass	-----
Crystal	Clear
Input	120V AC,60HZ,AC

Shade	-----
Length/Dia.	22"
Width/Ext.	-----
Height	15"
Maximum	85"
Lumens	-----

Light Source	G9
Bulb Info.	9×40W
Included	-----
Dimmable	No
Color	-----
Weight	22.2KG