

Trade Mark:
CRYSTAL WORLD INC

Product Name: Pendant lamp
Model :5049C18
120Vac, 60Hz,AC ONLY
Lamp Size:D18"H15"

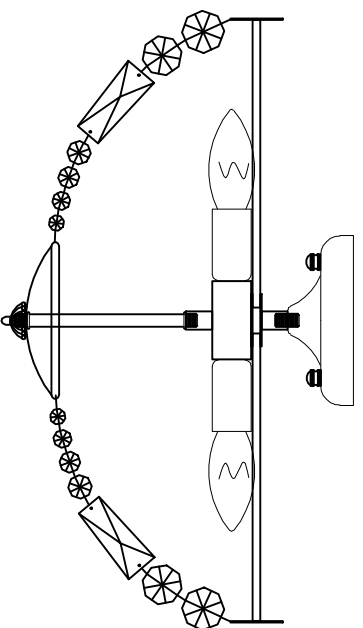

PENDANT LAMP ASSEMBLY INSTRUCTIONS









1. Place fixture(A) onto mounting screws (DD), secure with cap nuts (AA).
2. Please fix (A) with (B), (B) with (C).

Hardware Used

AA Cap nut		X 2
DD Mounting screw		X 2

2. Please hang the crystal(1) to the fixture .



	1
	30mm*1PCS
	28mm*1PCS
	63mm*1PCS
	16mm*1PCS
	16mm*1PCS
	14mm*1PCS
	12mm*1PCS
	42PCS

3. Install light bulbs (not included).
Use bulb
120V E12 4*40W Max.

