

Trade Mark:  
CRYSTAL WORLD INC

Product Name: Wall lamp  
Model :5464W12DB-1  
120Vac, 60Hz,AC ONLY  
Lamp Size:W12"\*H12"\*E7"

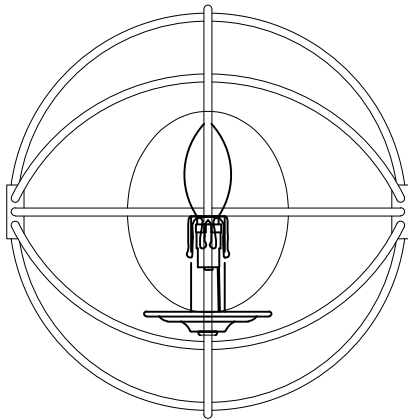

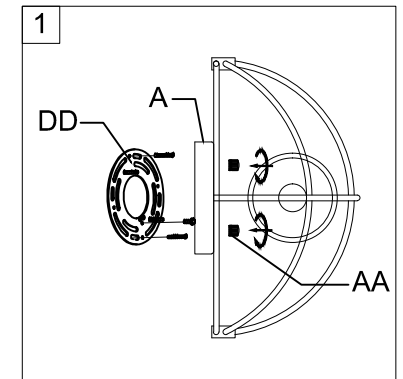

## WALL LAMP ASSEMBLY INSTRUCTIONS

1.Place fixture(A) onto mounting screws (DD).Secure with cap nuts (AA).



### Hardware Used

DD Mounting screw   
AA Cap nut 

2.Please fix(B) with (A) .

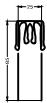
B  
  
1PCS

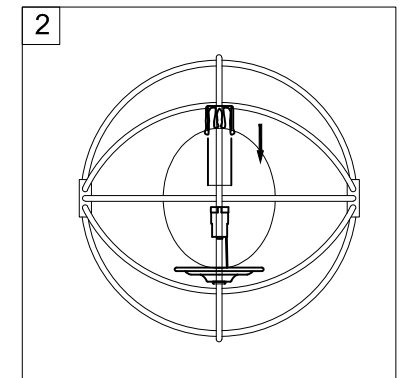

3.Install bulbs ( NOT INCLUDED).  
USE  
120V E12 1\*40W Max.

