

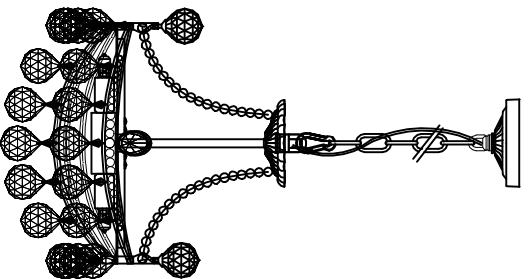

Trade Mark:
CRYSTAL WORLD INC





Product Name: Pendant lamp
Model :8041P12C-S
120Vac, 60Hz,AC ONLY
Lamp Size:L12"XW12"X13"H

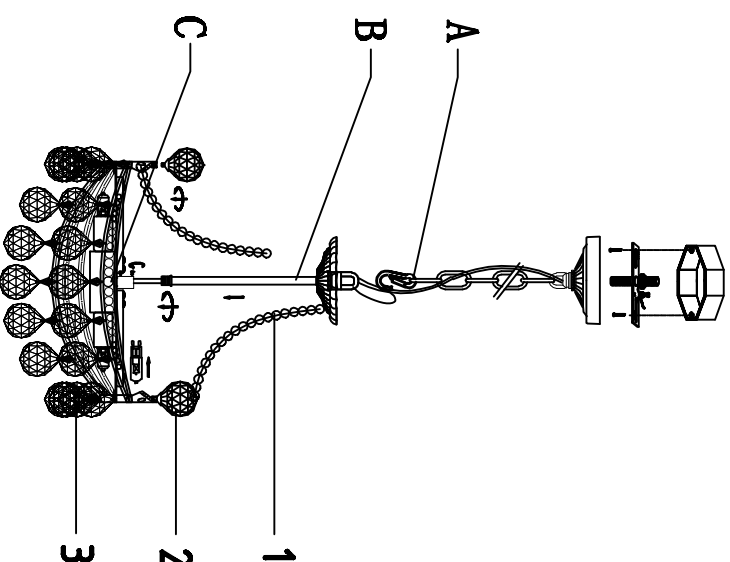

PENDANT LAMP ASSEMBLY INSTRUCTIONS

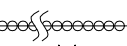
- 1.Screw part(B) onto the lampbody(C) secure with screw.
- 2.Please fix (A) with (B).
- 3.Please wear gloves when you hanging the crystal.
- 4.Install bulbs(NOT INCLUDED),USE 120V G9  4*40W Max.



- | | | | | | | | | | | | | |
|------|------------|---|------|-----------|---|---|-----------|---|---|-------|-----------|---|
| 1 | 10mm*24PCS |  | 1 | 40mm*1PCS |  | 2 | 40mm*1PCS |  | 3 | 49PCS | 40mm*1PCS |  |
| 4PCS | | | 4PCS | | | | | | | | | |

