

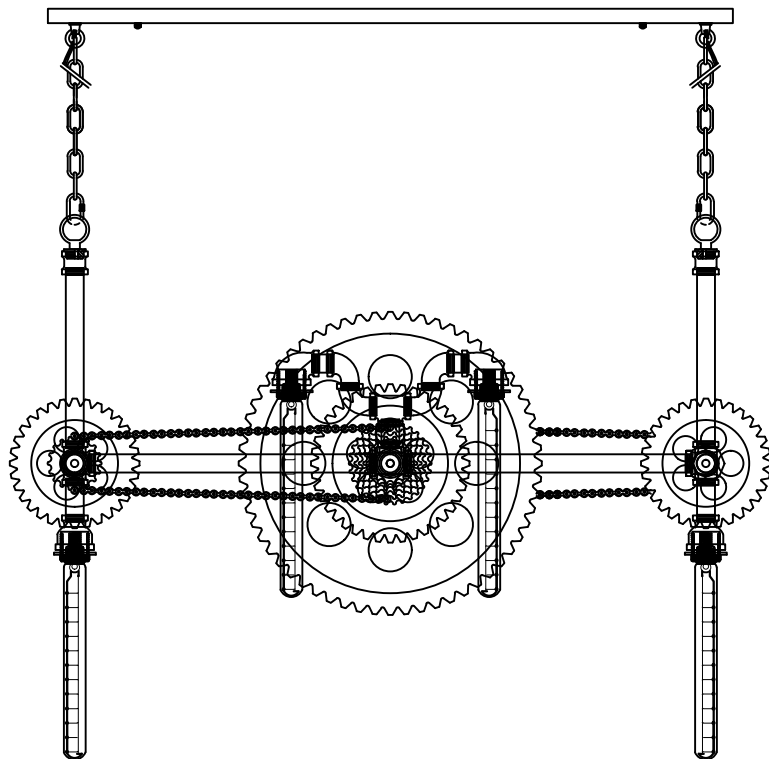

Trade Mark:  
CRYSTAL WORLD INC

Product Name: Pendant lamp  
Model :9712P41-6  
120Vac, 60Hz, AC ONLY  
Lamp Size:L41"\*W14"\*H24"



## PENDANT LAMP ASSEMBLY INSTRUCTIONS

1. Please take off the plastic sheet from the lamp body.
2. Install bulbs( NOT INCLUDED).USE **120V E26**  **6\*40W Max.**

