

CWI LIGHTING

BRIGHTER LIVING. SIMPLIFIED.

PROJECT: _____

FIXTURE TYPE: _____

LOCATION: _____

CONTACT/PHONE: _____

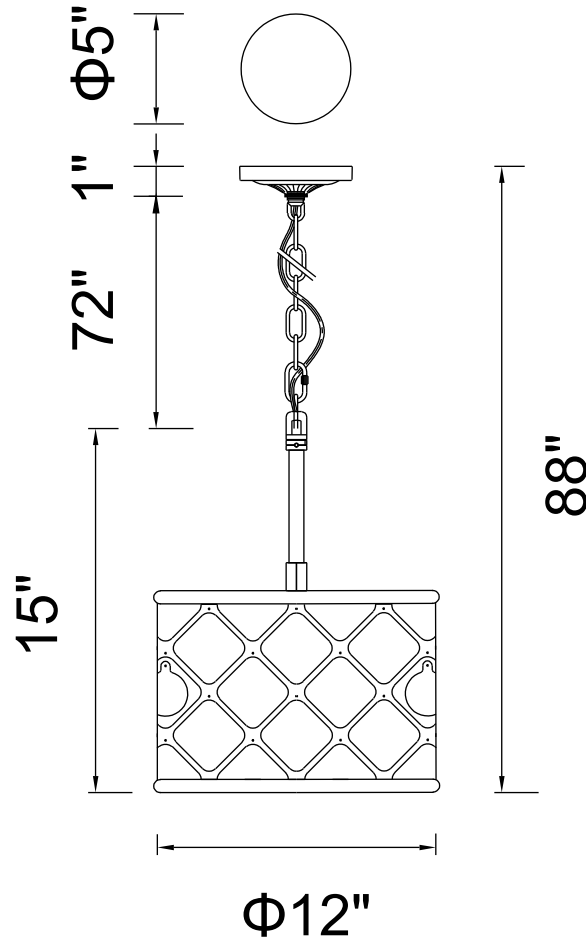

Item	9862P12-3-101
Collection	RENOUS
Finish	Black
Glass	-----
Crystal	Clear
Input	120V AC,60HZ,AC

Shade	-----
Length/Dia.	12"
Width/Ext.	-----
Height	15"
Maximum	88"
Lumens	-----

Light Source	E12
Bulb Info.	3×60W
Included	-----
Dimmable	No
Color	-----
Weight	