

# CWI LIGHTING

BRIGHTER LIVING. SIMPLIFIED.

PROJECT: \_\_\_\_\_

FIXTURE TYPE: \_\_\_\_\_

LOCATION: \_\_\_\_\_

CONTACT/PHONE: \_\_\_\_\_

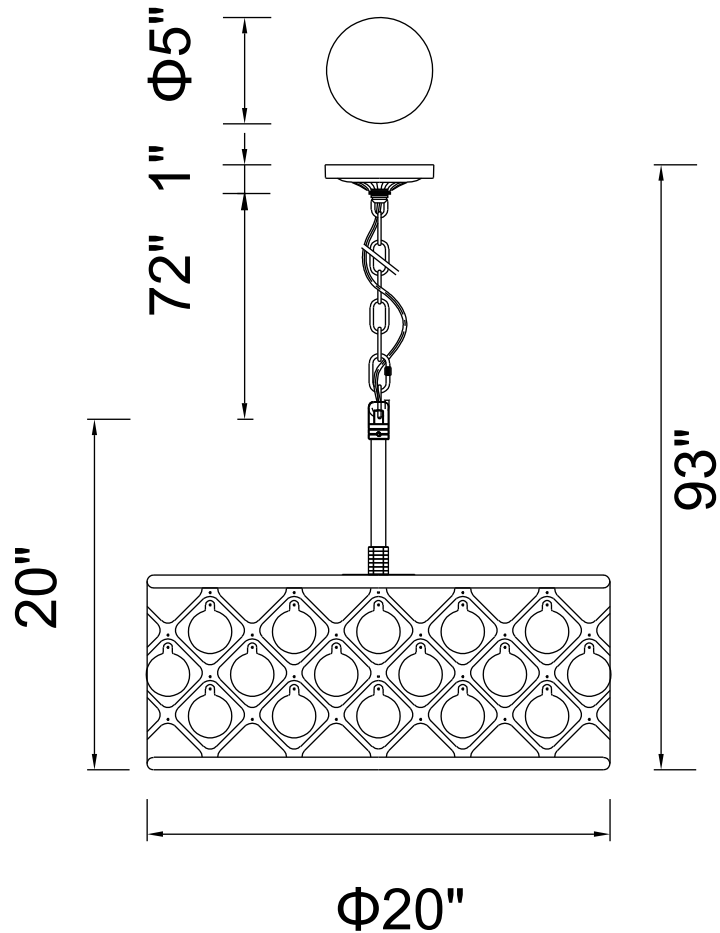

Item	9862P20-5-101
Collection	RENOUS
Finish	Black
Glass	-----
Crystal	Clear
Input	120V AC,60HZ,AC

Shade	-----
Length/Dia.	20"
Width/Ext.	-----
Height	20"
Maximum	93"
Lumens	-----

Light Source	E12
Bulb Info.	5×60W
Included	-----
Dimmable	No
Color	-----
Weight	